



**ama**<sup>®</sup>

***Oferta części do  
Maszyn  
Rolniczych***



**Componenti per un  
mondo in movimento**

**ama**



80.000 klientów



525.000 artykułów



18 zakładów  
produkcyjnych w  
Europie



1020 pracowników



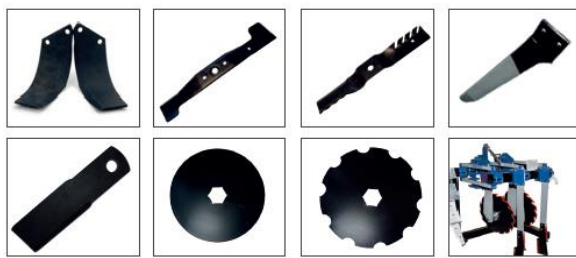

AMA Divisione Cardan Casoli (CH) Italia



AMA Divisione Sara Collepepe (PG) Italia



Nuova Azzimondi & Friggeri Quattro Castella (RE) Italia



Seat Plastic Mancasale (RE) Italia



Lo Snodo Rolo (RE) Italia



AMA Refluid San Martino in Rio (RE) Italia



AMA Divisione IMEL San Martino in Rio (RE) Italia



### Wąty przegubowo teleskopowe od 210 Nm do 1918 Nm

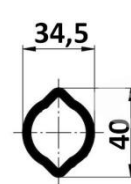
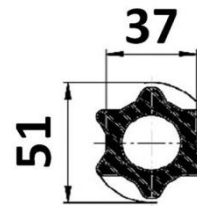
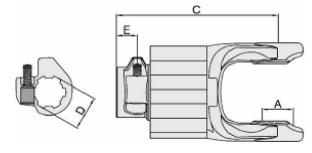
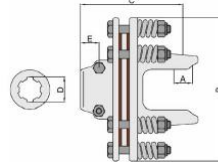
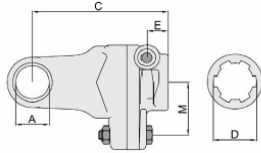
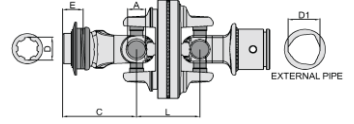
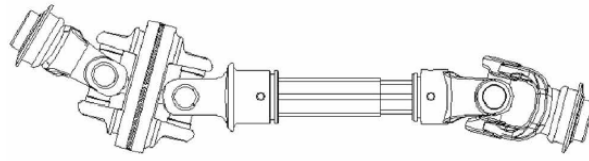

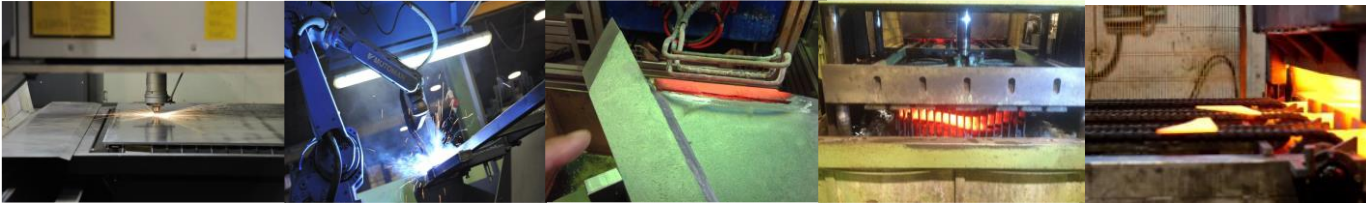

## Głębosz typ MICHEL



## Pług Dłutowy



*Niniejsza prezentacja przedstawia tylko wybrane artykuły z oferty AMA*

## PŁUG DŁUTOWY SMALL

RIPPER

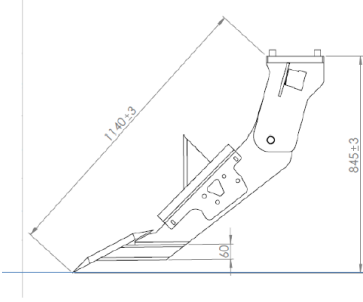

Profil słupicy – 35 mm  
Szerokość dłuta – 100 mm  
Max głębokość pracy – 60 cm

RIPPER SMALL

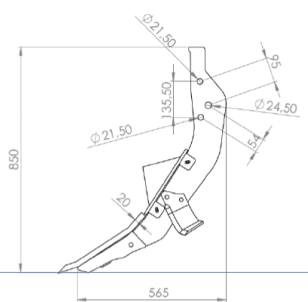

Profil słupicy – 30 mm  
Szerokość dłuta – 80 mm  
Max głębokość pracy – 45 cm



CP7095

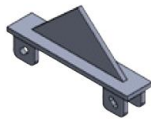

CP7096

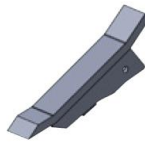

CP7097



CP6070



CP6071

## Sprężyna 90x13

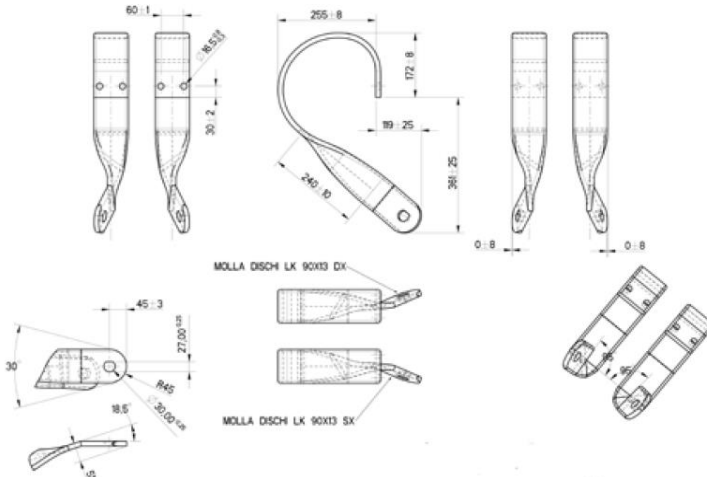

## Sprężyna 80x10 / 45x10

## Sprężyna 30x30 , 35x35, 40x40

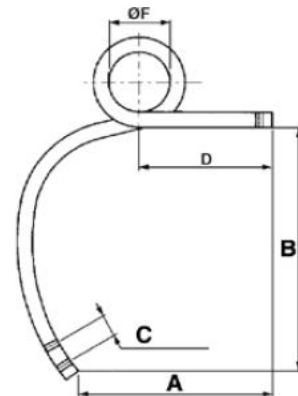
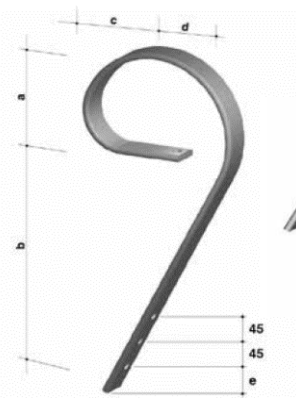

## Elementy napawane



### Typ – Lemken 620 x 6 mm

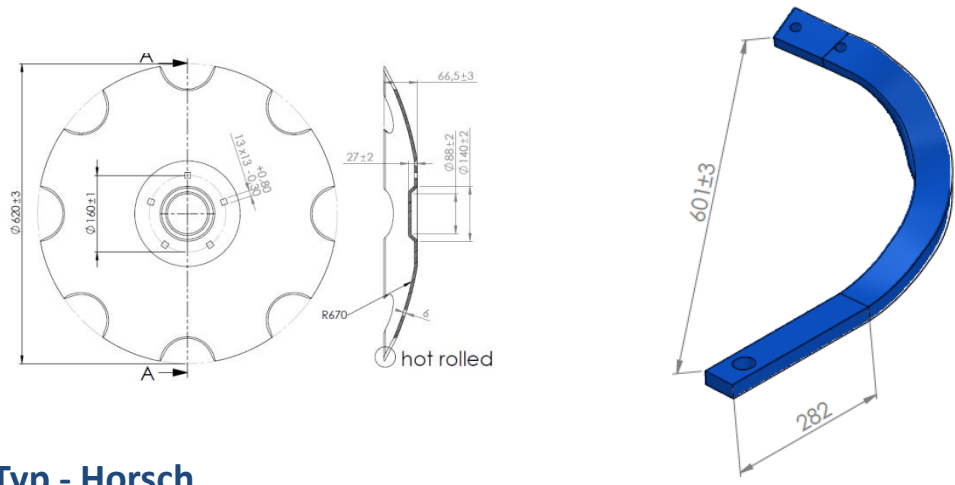

### Typ - Horsch



### Typ - Kongskilde Delta Flex

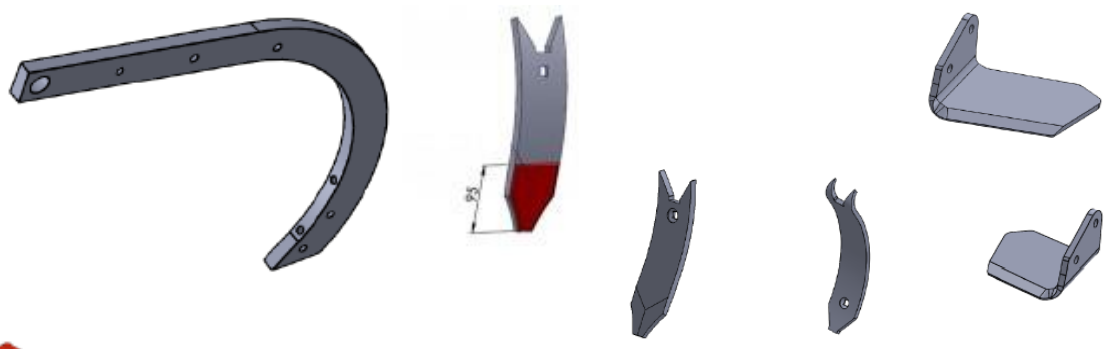

### Elementy pługów



Niniejsza prezentacja przedstawia tylko wybrane artykuły z oferty AMA



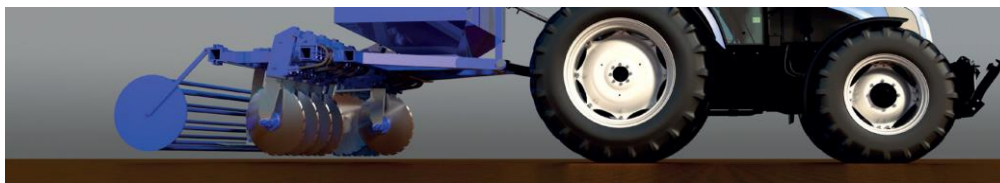

## Mulching Tillage Unit

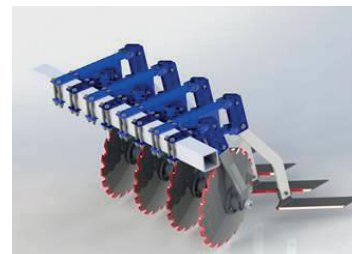
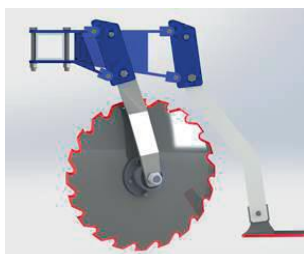
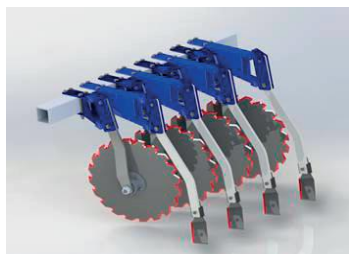

Redukuje czas i koszty

Zwiększa wydajność

Polepsza jakość nawożenia

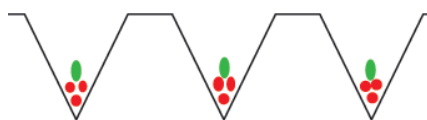

Legend:

— Nawóz sztuczny  
— Nasiona

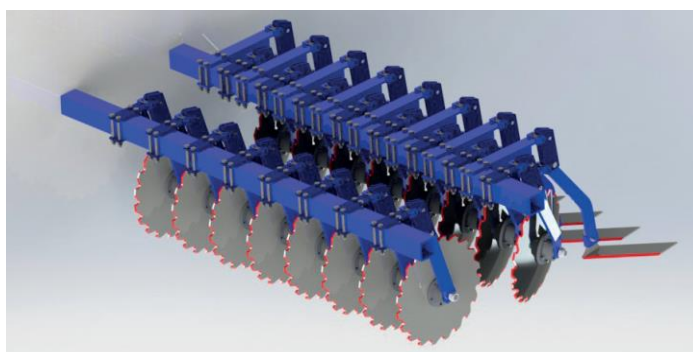
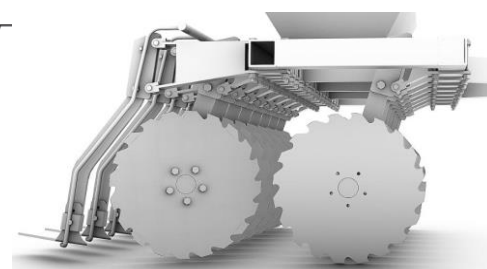

Szybkość pracy: 12-15 km/h

Jednoczesny wysiew nawozów i nasion

Idealnie rozdrabnia i miesza glebę

Ma niskie zapotrzebowanie na moc

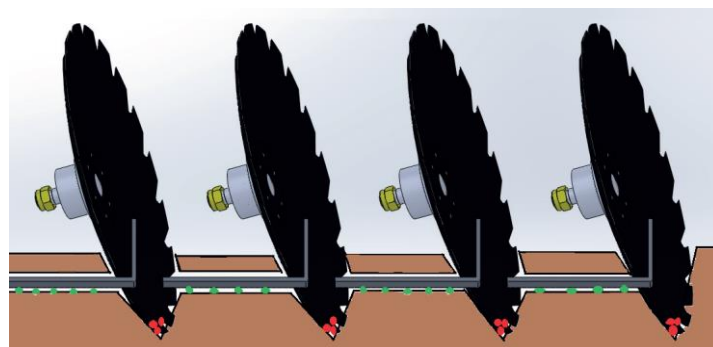
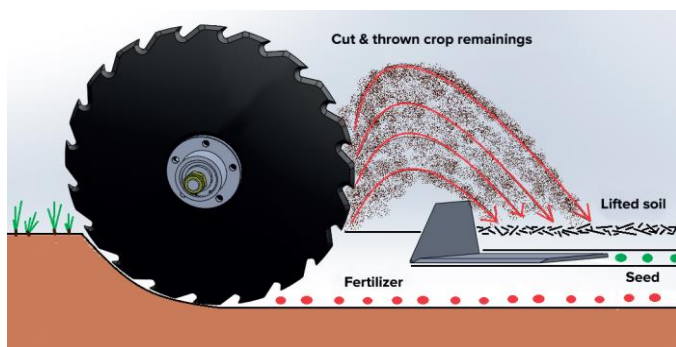





**Materiał: stal borowa 30MNB5**  
**Twardość: 48-52 HRC**  
**Metoda ostrzenia: walcowanie na gorąco**



**Talerze robocze, średnica od 400 do 710 mm, grubość od 3 do 8 mm**  
**Wiele typów, kształtów, mocowanie zgodne z zamówieniem odbiorcy**

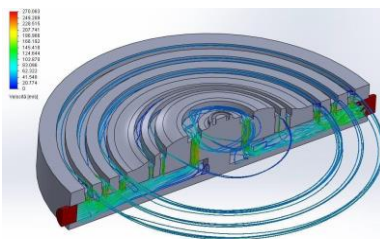
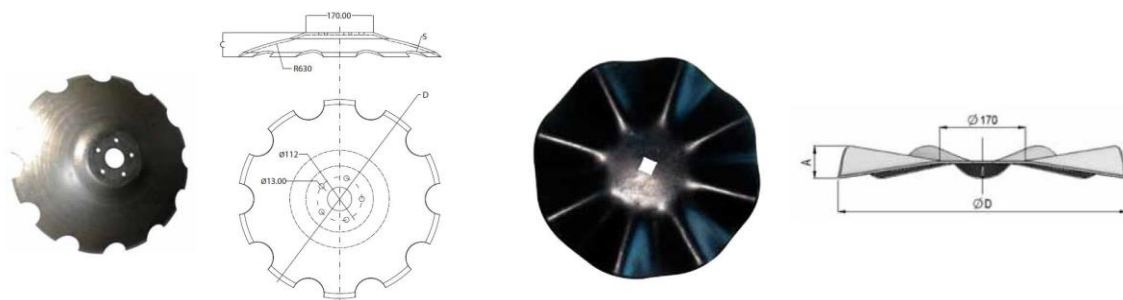
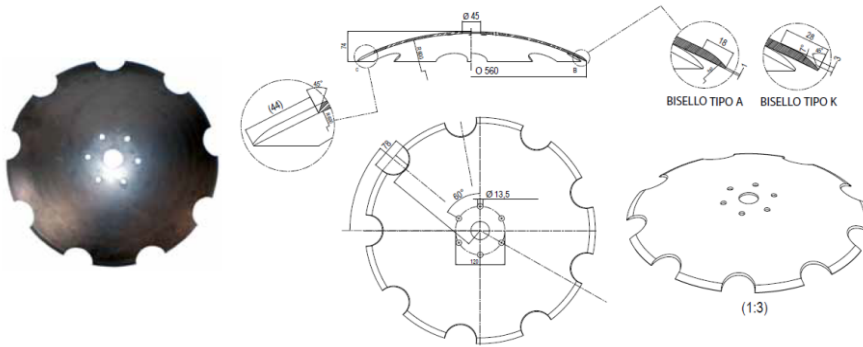



**Zęby glebogryzarek, formowane promieniście dla mniejszych oporów pracy**  
**Materiał: stal borowa 30MNB5**

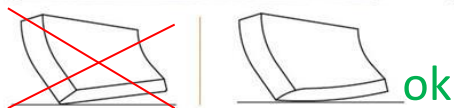
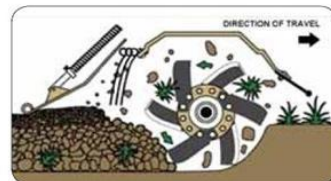
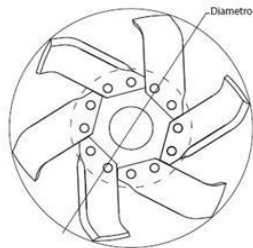

**Noże bron wirowych, Materiał: stal borowa 30MNB5**

**Noże**



**Dłuto typ ATTILA - ARTIGLO**

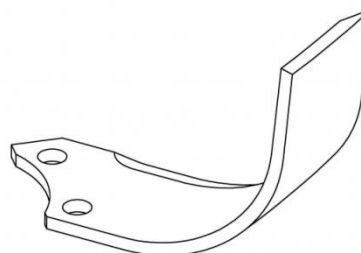
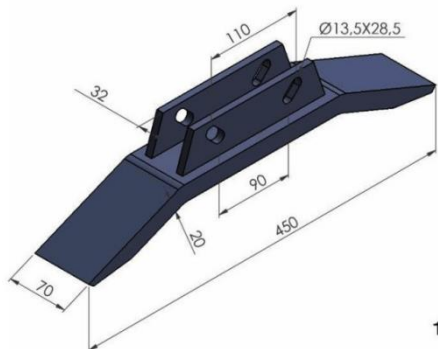
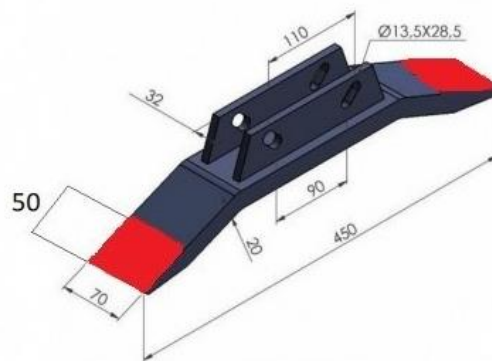

Noże

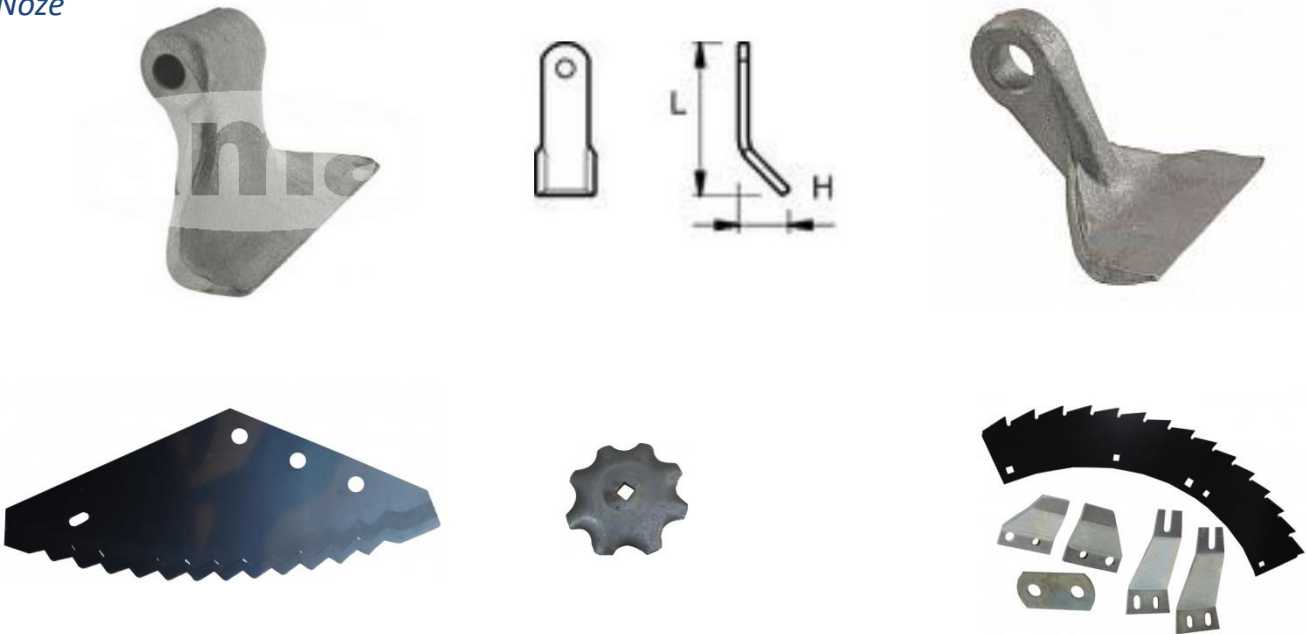

Ostony

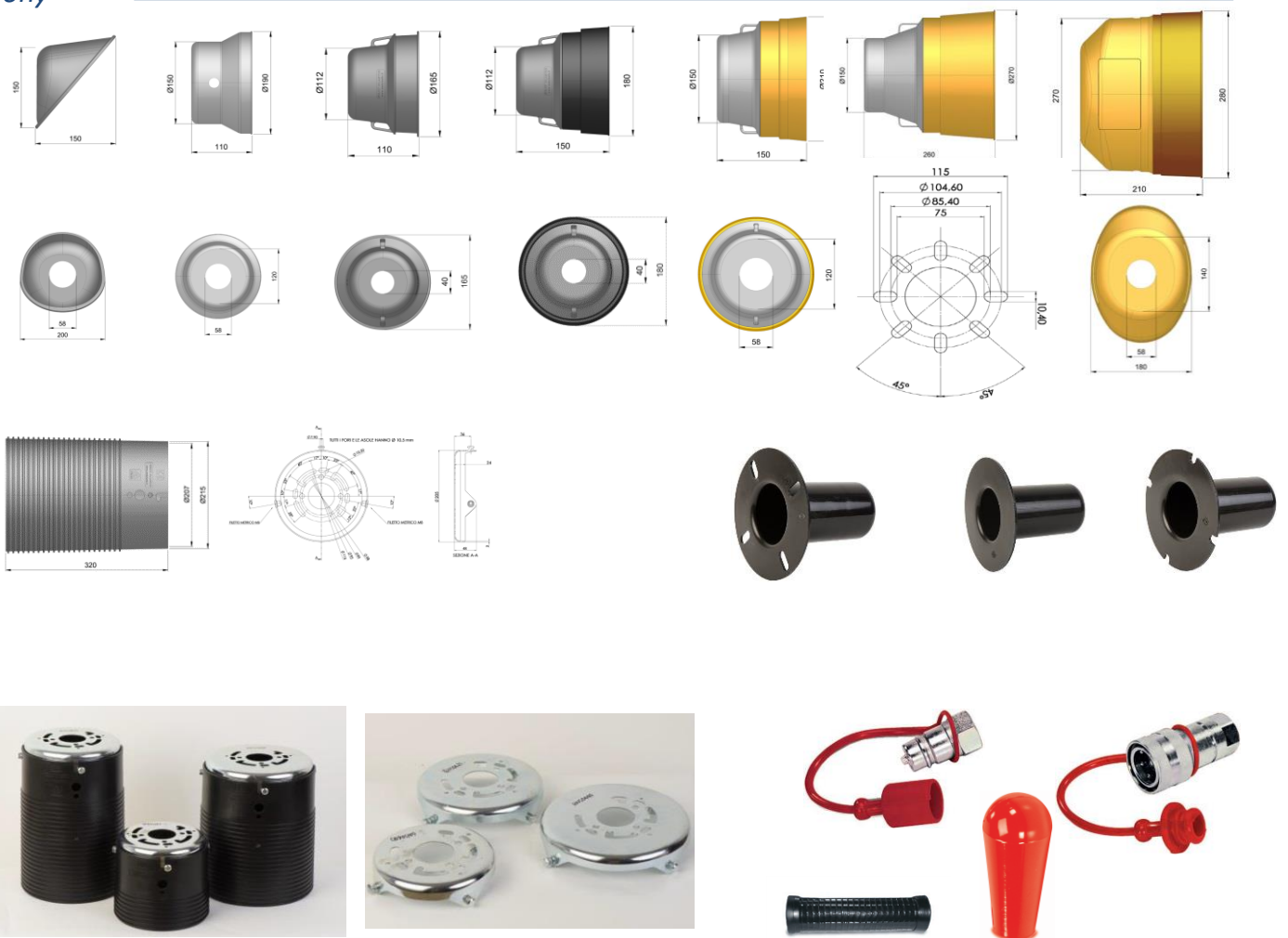



Fotele operatora, kolumny kierownicze, kierownice



Oświetlenie

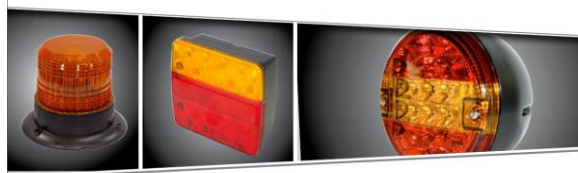

Niniejsza prezentacja przedstawia tylko wybrane artykuły z oferty AMA

*Trójpunktowy układ zawieszenia*



*Łączniki kat 1,2,3 z gwintem do 40x3*

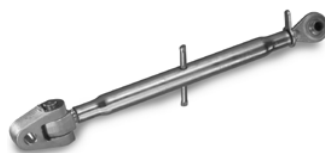

*Łączniki hydrauliczne i elementy do spawania*

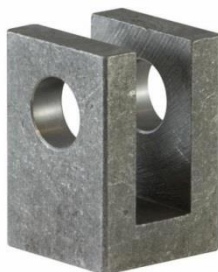

*Dowolne długości i końcówki*

*Haki kat. 2s, 2, 3*



*Akcesoria*





Pompy

---



Siłowniki

---





Hydrauliczne



## Zaufali nam:

▪ JOHN DEERE



JOHN DEERE

▪ KVERNELAND



▪ KUHN



▪ AGRISEM



▪ GREGOIRE BESSON

▪ BONNEL



▪ ALTEC



ALTEC

▪ SIMBA



▪ SUMO



▪ COUSINS OF EMNETH



▪ HERCULANO



▪ BRIX



▪ RAZOL



▪ EVERS AGRO



AMA Poland Sp. z o.o.  
ul. Zwoleńska 120/11  
04-761 Warszawa  
tel. 801 989 990  
tel. 22 769 76 61  
e-mail: [info@ama-parts.pl](mailto:info@ama-parts.pl)  
[www.ama-parts.pl](http://www.ama-parts.pl)